



**AUSTRALIAN AUTOMOTIVE
AFTERMARKET ASSOCIATION**

Safe Towing Guide

Document Reference Number: AAAA-STG-01



CONTENTS

DEFINITIONS.....	2
Tow Vehicle.....	3
Loading.....	4
Weights	4
Vehicle Loading	5
Trailer Loading	6
Caravan Loading.....	7
Vehicle & Trailer Coupling.....	7
The Hitch Mount or Tongue.....	7
Hitches	8
Tow Hitch Downloads	9
The Tow Hitch/Ball.....	9
Weight Distribution Hitches.....	10
Operation of Vehicles & Trailers Coupled Together	11
Stability	11
ADDITIONAL IMPORTANT INFORMATION	12
Towing Capacities	12
Regulations	12
Sway Control Devices.....	12
Trailer Towing Tips.....	12
Trailer Lights.....	12
Trailer Brakes	12
Safety Chains.....	13
Shackles.....	13
Before Towing.....	14
Tow Bar Tongue	14
Anti-Rattle Bolt.....	14
Maintenance.....	14



DEFINITIONS

Gross Vehicle Mass or Weight (GVM/GVW)

The maximum your vehicle can weigh when fully laden. This is the weight transferred to the ground through the wheels with a trailer attached if towing.

Tow Hitch Download

The weight imposed on the tow vehicle's tow hitch (ball or other type) by the coupling of the trailer onto the tow bar.

Kerb or Unladen Mass

The mass of the vehicle in running order unoccupied and unladen with all fluid reservoirs filled to the maximum level including fuel, and with all standard equipment.

Tare Mass or Weight

Is the same as Kerb Weight but with only 10 litres of fuel in the fuel tank instead of a full tank.

Axle Capacity

The maximum allowable load on that axle (front or rear), as specified by the Manufacturer.

Gross Trailer Mass (GTM)

The mass transmitted to the ground by the tyres of the trailer when coupled to a vehicle and carrying the maximum load recommended for the trailer, with the weight uniformly distributed over the load bearing areas.

Gross Combination Mass (GCM)

Value specified for the vehicle by the 'Manufacturer' as being the maximum weight of the towing vehicle and any trailer while coupled together in their as-used condition. This may be less than the sum of the 'GVM' and towing capacity of the vehicle.

Aggregate Trailer Mass (ATM) or Gross Trailer Weight (GTW)

The maximum allowable mass or weight of the trailer specified by the manufacturer. ATM is the sum of GTM plus the tow hitch download.

Payload

The allowable load carrying capacity or 'payload' is worked out by deducting the trailer "Tare Mass" from the "ATM". It must not be exceeded under any circumstances. Safety, insurance & warranty may be affected if the specified payload is exceeded.

Component Registration Number (CRN)

All certified towing tow bars receive a unique CRN and a make model. The make is the component manufacturer's name, the model is the component manufacturer's document reference number from the evidence plus the ADR number.



DISCLAIMER

This publication is intended as a general guide only and covers single or tandem type trailers or caravans, of less than 4,500kgs ATM, being towed via a rigid drawbar using a suitable coupling. This publication is not intended for use with dog trailers or trailers of more than 4,500kgs.

To ensure the safety of yourself and other road users, you must abide by the laws governing the towing of trailers. These are:

- The vehicle and trailer must comply with all relevant registration requirements;
- The vehicle and trailer must be in a roadworthy and safe condition;
- Towbars and couplings must not obscure the towing vehicle's number plate or rear lights when the trailer is not connected;
- Towing more than one trailer is prohibited in most states;
- People are not permitted to ride in trailers or caravans;
- The speed limit for a vehicle towing a trailer is the same as the base vehicle or as defined by state regulations.

Tow Vehicle

If you are going to purchase a trailer or caravan, it is critical that you give careful consideration to your vehicle's towing mass, GVM, GCM, axle capacity rating, and tow hitch download rating, and construction prior to making your purchase.

You will find these ratings your vehicle manufacturer's handbook.

If no brakes are fitted to a trailer; then 750kgs is the maximum permissible towing capacity. With regards to tow vehicles, if the towbar fitted exceeds the capacity approved by the vehicle manufacturer for that variant, the lesser of the two values shall be the towing capacity. In some cases, some additional (strengthening) materials are supplied with the certified towbar as part of the fitting kit.

All trailers of 750kgs GTM or more must be fitted with brakes.

Loading

Weights

Before towing confirm the total GVM, GTM, trailer tow hitch download, and gross vehicle axle weights are all within the limits stated by the vehicle and trailer manufacturers. The GVM can be found either in the “Trailer Towing” section of a vehicle owner’s manual or on the vehicle compliance plate. The GTM may affect the load carrying capacity of the vehicle.

Examples of varying load conditions: Vehicle GVM = 2 740 kg
GCM = 4 600 kg, Maximum Total Trailer Weight = 2 250kg

If the trailer is loaded to maximum, then: 4 600 kg – 2 250 kg = 2 350 kg maximum allowable vehicle load.

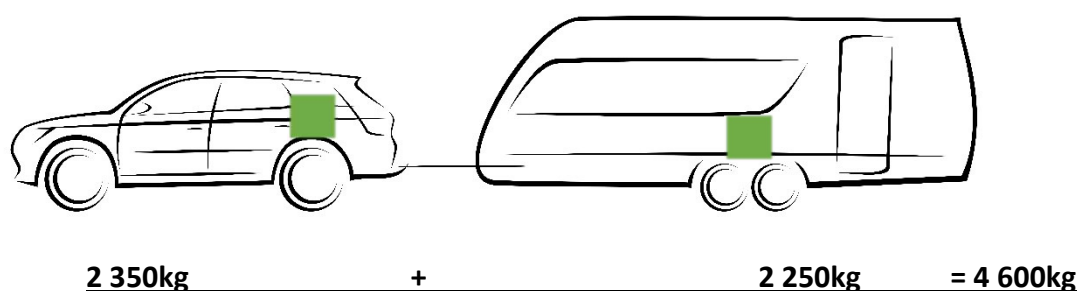

If the vehicle is loaded to maximum, then: 4600 kg - 2740 = 1860 kg maximum allowable trailer load.

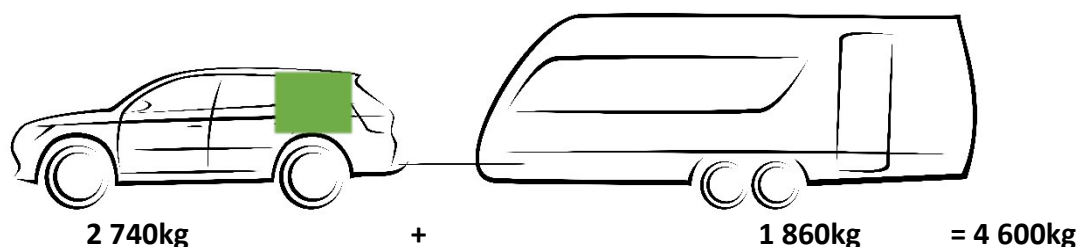

In this instance, the vehicle is loaded to maximum and the trailer is loaded to maximum. The total weight has exceeded the allowable limit.

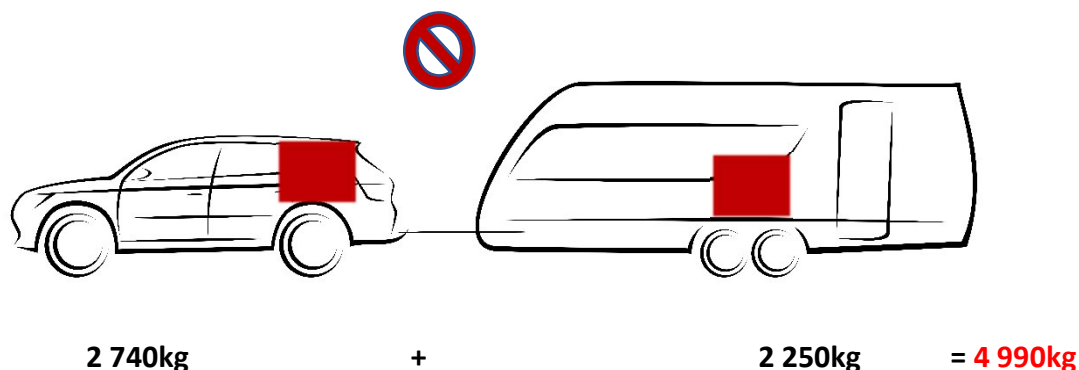



Vehicle Loading

Towing any type of trailer will affect the vehicle's handling, performance, braking, durability and fuel consumption.

For your safety and the safety of others, do not overload the vehicle or trailer.

Confirm your vehicle's GVM or GVW and check the vehicle owner's manual for information on your vehicle's GVM.

As every vehicle is different, it is recommended to refer to the manufacturers recommended load carrying guide.

Trailer Loading

Always ensure heavy items are placed as close to the trailer axle group, and as low down as possible. Tow hitch download can be significantly affected due to loading and should always be checked after loading.

Ensure the trailer coupling is the same height as the vehicle coupling point. In the first instance, always distribute vehicle and trailer loads accordingly to achieve a relatively flat vehicle and trailer posture without the assistance of load levelling or load distribution devices.

Overloading a trailer will place undue stress on the components of the trailer, tow bar and tow vehicle.

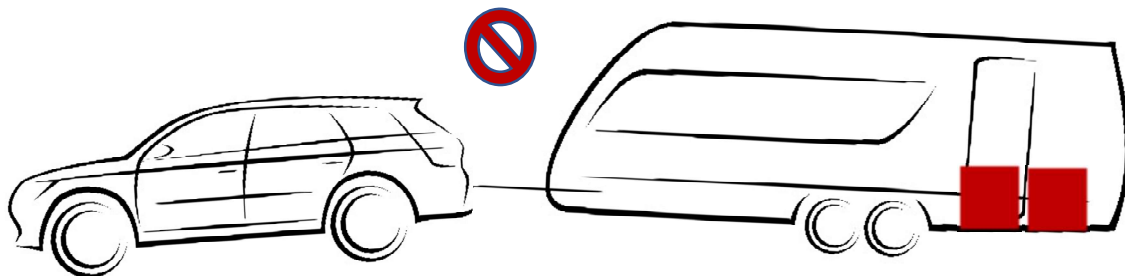
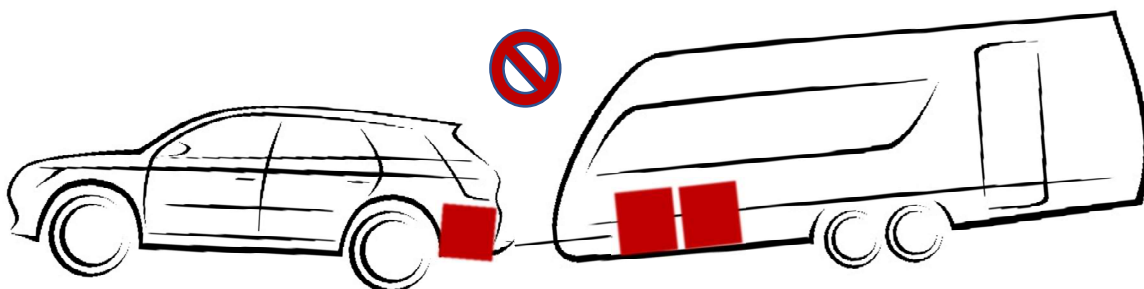
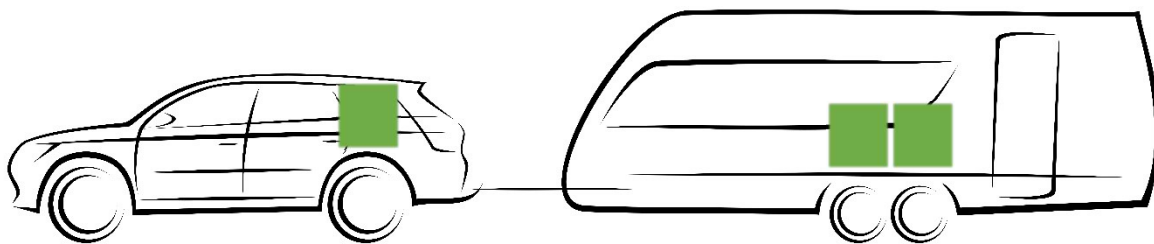



Caravan Loading

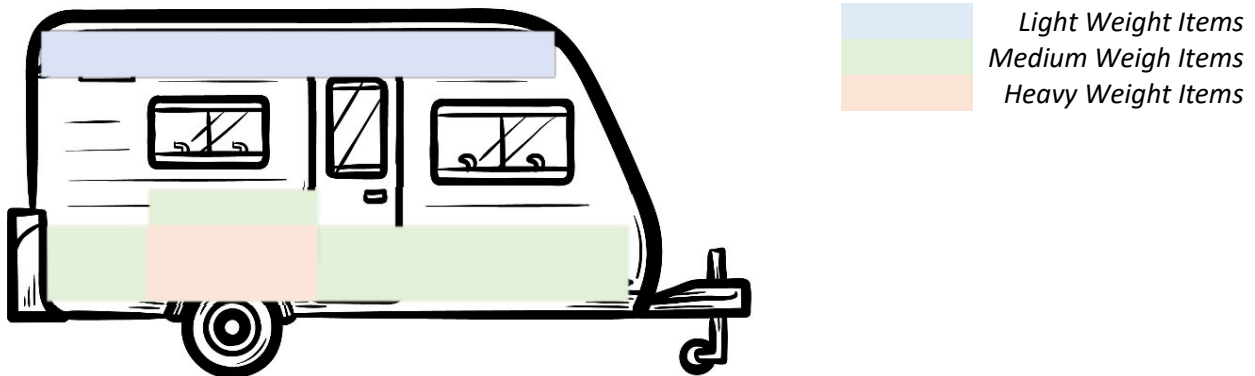

Vehicle & Trailer Coupling

Always ensure tow bars and couplings are compliant with Australian Design Rules (ADR) and relevant Australian Standards.

Unless a permanent part of the vehicle, it is compulsory for all towbars and couplings manufactured after 1 July 1988 to clearly and permanently display the maximum load rated capacity plus the make and model of vehicle for which they are intended, or alternatively, the manufacturer's name, trade mark/CRN and part number.

Typical approved couplings for trailers are:

- 50 mm ball couplings or other style couplings for trailers with an ATM up to 3,500 kg; and
- 75mm ball, pintle hook or other type couplings for trailers with an ATM up to 4,500 kg.

The Hitch Mount or Tongue

The hitch mount, also known as the tongue, is the section of the towbar to which the tow ball, pin, block, or other coupling is attached.

If the hitch mount or tongue obscures the number plate it must be removed from the towbar when the trailer is not attached.

Hitches

Always use a tow bar coupling appropriate for the type of towing to be undertaken. If travelling off road, use a high articulation towing coupling.

Always maintain the tow bar pivot point (tow hitch) position, as specified by the tow bar manufacturer.

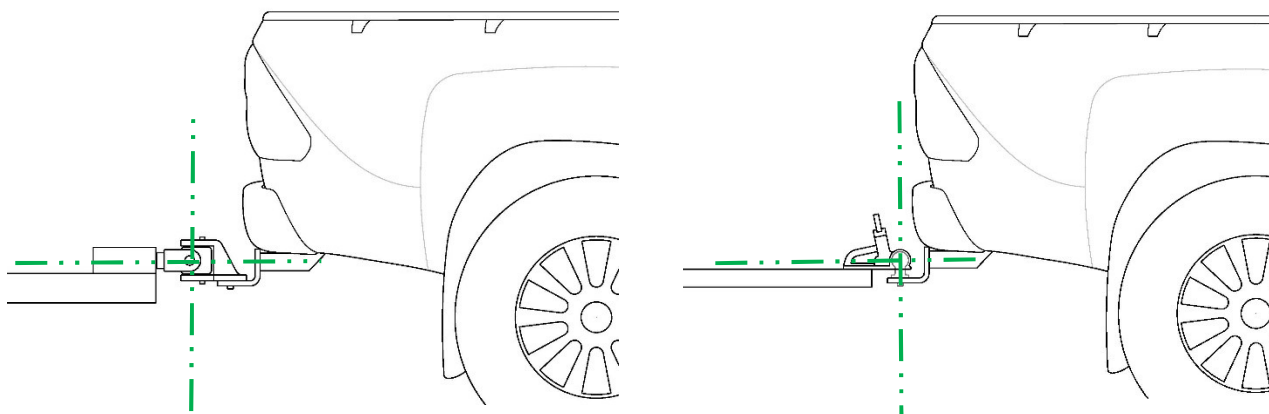

CAUTION

High articulation couplings when used with a weight distribution system should only be used for highway driving. Do not use for articulated off-road driving.

The levelness of the trailer may be adjusted on some tow bars by inverting the tow ball tongue to more appropriately suit the trailer.

NOTE

- Some tow bar tongues are in the inverted position as standard.
- Some tow bar tongues cannot be inverted. Tow ball position can only be changed to allowable tow bar designed positions. The load rating may change with a different orientation of the tow bar tongue.
- A tow bar that can be inverted will have a plaque fitted to the tow bar showing the position that it can be changed to and the load rating in the changed position.



Tow Hitch Downloads

Trailer cargo load should be distributed so the tow hitch download is within the specification shown in the vehicle owner's manual and tow bar ID plate.

The tow hitch download is measured in kilograms carried by the tow bar and must not exceed the maximum load for the vehicle/tow bar design. Tow hitch download as a guide should be 8-10% of the ATM, up to the tow bar load limit. Variation above or below tow hitch download reduces stability of the combination. It should be noted that some trailers/caravans may require a lower tow hitch download due to the design- for example European style systems. Trailer tow hitch download weight can be determined by weighing the trailer at the coupling point. Always have the tow hitch coupling at the same height as it is when coupled to the vehicle in the loaded condition.

Trailer tow hitch download weight must be included as part of the tow vehicle GVM.

The Tow Hitch/Ball

Based on ADRs and Australian Standards, tow hitches and balls suitable for ATM weights up to 4,500kg must have the manufacturer's name, or CRN, stamped on the tow ball.

If using a 50mm tow ball, with the tow vehicle in it's as-used state, the towbar on the towing vehicle must be capable of being mounted (adjusted) to any one height within the range of 350mm to 460mm (from the ground to the centre of the tow ball). There are no height restrictions on other types of hitches.

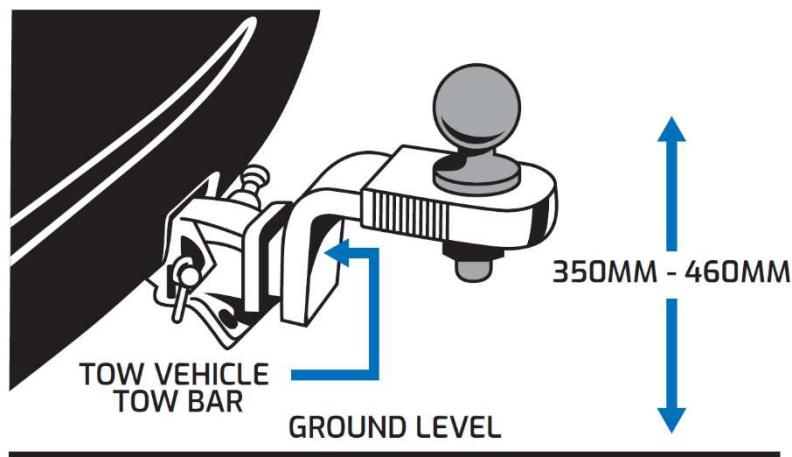

The most commonly used 50mm diameter tow balls are not rated beyond 3,500kgs. Towing 3,500kgs to 4,500kgs requires the use of a 75mm tow ball or other coupling rated to the ATM of the trailer.



Weight Distribution Hitches

When towing, in some cases, the additional weight of towing a trailer or caravan can exceed the ability of the rear suspension to maintain its height relative to the front suspension (the rear suspension will lower and cause the front suspension to raise). This potentially leads to a loss of steering/front brake performance and misaligned headlights. Installing a correctly engineered weight distribution system can help redistribute the weight more evenly across the vehicle, levelling the drawbar and thereby assists the vehicle to maintain its original dynamics.

When choosing a weight distribution system, it is important to match the weight category of the system to your towing needs and tow ball download weight. If the weight category is too low, the weight distribution system will apply inadequate force resulting in insufficient levelling.

Conversely, if the weight category greatly exceeds your requirements, the over rated system will apply too much load transfer to the vehicle. When using a weight distribution system, always ensure that it is installed and used as per the manufacturer's instructions and specifications.

A weight distribution system must **NOT** be used:

- to correct a hitch with excessive download
- to correct a rear axle overloading issue
- where the vehicle, trailer/caravan, towbar, or hitch manufacturer advises against its use



Operation of Vehicles & Trailers Coupled Together

Always ensure that the trailer you are towing complies with all the regulations governing trailers in Australia.

Stability

There are many factors that will influence the stability of your vehicle and or trailer/caravan.

Tyre Pressures

Ensure all tyre pressures are to vehicle's specifications.

Vehicle Axle Load

Ensure vehicle axle load is within vehicle specifications.

Trailer Weight

Check maximum loaded weight does not exceed vehicle specifications, or tow bar towing capacity.

GVM

Check maximum loaded weight of vehicle is not in excess of vehicle specifications, redistribute load and weight in trailer and vehicle.

GCM

Maximum weight transmitted to the ground by the wheels, of the loaded towing vehicle and trailer, while connected in it's as-towed condition

Tow Hitch Download

Ensure tow hitch download is to manufacturer's specifications.

Driving Style

Optimise driving style to suit trailer towing and road conditions. No fast steering inputs, hard braking, or high speeds.

Suspension

Check vehicle suspension for any wear or broken components. Repair accordingly.

Vehicle and Trailer Alignment

Check suspension alignment on vehicle and trailer. Adjust or repair accordingly.

Wind

Be aware of cross winds and sudden gusts, or wind buffeting from larger vehicles. Reduce speed accordingly.



ADDITIONAL IMPORTANT INFORMATION

Towing Capacities

For vehicle towing capacities refer to the “Trailer Towing” section of the owner’s manual, and tow bar plaque.

Note:

- Ensure that your tow bar’s towing capacity can tow the load that you intend to apply to it.
- Vehicle weight and trailer weight can be measured at a public weigh bridge.
- If unsure of your vehicle’s compliance seek specialist advice.

Regulations

Ensure the trailer load distribution, axle loads, vehicle loading, trailer lights, trailer brakes and rear-view mirrors comply with all Federal and State regulations.

Sway Control Devices

Refer to the manufacturer’s instructions and ratings.

Trailer Towing Tips

Refer to your vehicle owner’s manual for towing tips for your vehicle.

Trailer Lights

Trailer lights must comply with federal and state regulations. Check for correct operation of the trailer lights each time you attach the trailer. Direct splicing of the light to the vehicle wiring harness may damage your vehicle’s electrical system.

Trailer Brakes

When your trailer exceeds a certain weight, trailer brakes are required. There are federal and state regulations for Trailer brakes.

Trailers that do not exceed 4,500kg must be fitted with an efficient brake system that complies with ADR 38.

For trailers up to 2,000 kg GTM, an efficient braking system is considered to have brakes operating on the wheels of at least one axle. Over-run brakes may only be used on trailers that do not exceed 2 tonnes GTM.

Every trailer over 2,000 kg GTM must have brakes operating on all wheels. The brake system must cause immediate application of the trailer brakes in the event of the trailer becoming detached.



Safety Chains

Safety chains must always be used when towing a trailer. Trailers less than 2,500kgs ATM must be fitted with at least one safety chain. Trailers over 2,500kgs ATM and up to 3,500kgs must have two safety chains fitted. The chain shall be permanently and legibly marked with the manufacturer’s or importer’s identification, the digits “4177-” to display compliance with Australian Standard 4177.4, followed by first two digits of chain designation (i.e. 25 for 2500kgs).

Trailers over 3,500 kg ATM must have two safety chains made from steel of a minimum 800 MPa breaking stress that conforms to the mechanical properties of Grade T chain, as specified in AS2321.

Shackles

Either “Bow” or “D” shackle design is suitable, although it is noted that the “Bow” design provides a greater angular displacement.

A significant detail to understand is that the breaking load of a shackle is generally six times the working load limit.

The current standard applying to shackles is AS 2741-2002, however this standard does not specifically cover the use of rated shackles in an application such as attaching a trailer to a tow bar. This standard covers the use of shackles for lifting purposes.

However, some state authorities provide guidelines or advise for selecting suitable shackles. For example, refer the following guidance for selecting a suitable shackle.

This table is a guide only for suitable “D” shackle size:

Trailer ATM (kg)	Chain Size Classification AS 4177.4-2004	Chain Marking AS 4177.4-2004	Suitable rated D Shackle size AS 2741-2002 Grade “S” or “6 dee” or “6 bow”	Minimum Proof Load Strength (kN) Chain/Shackle
Up to 1 000	1 000	4177-10	6mm S WLL 0.5T	4.9 / 9.9
Up to 1 600	1 600	4177-16	6mm S WLL 0.5T	7.9 / 9.9
Up to 2 500	2 500	4177-25	8mm S WLL 0.75T	12.3 / 14.8
Up to 3 500	3 500	4177-35	10mm S WLL 1.0T	17.2 / 19.7
	AS 2321-2014	AS 2321-2014		
Up to 4 500	Grade T	T, 8, 80, or 800	10mm S WLL 1.0T	*/ 19.7

*For 3,500-4,500kg, each chain must be sized such that minimum braking load exceeds ATM.

NOTE

Chain selected may be larger than the minimum for load because of the internal clearance to fit the shackle pin.



Before Towing

Before you begin towing your trailer, it is strongly recommended that you carry out a pre-towing safety check. These checks include, but are not limited to:

- Correct vehicle tyre pressures
- Correct trailer tyre pressures
- Ensure the trailer lights operate correctly
- Ensure the tow ball is correctly tensioned
- Ensure the trailer cargo is secured

Tow Bar Tongue

The load rating may change with a different orientation of the tow bar tongue. A tow bar that can be inverted will have a plaque fitted to the tow bar showing the position that it can be changed to and the load rating in the changed position.

Anti-Rattle Bolt

Removal of the tow bar tongue is recommended when not in use. The anti-rattle bolt and nut (where fitted) is designed to prevent movement of the tow bar tongue when the tongue is unloaded. The anti-rattle bolt must be removed when towing or damage to the tow bar may occur.

Maintenance

Vehicle

Towing a trailer puts an additional load on your vehicle, therefore it will require more frequent servicing. The trailer's wheel bearings, suspension and brakes must all be in good working order and tyres must be properly inflated

Tow bar

Frequent towing or towing of heavy loads, towing off-road or in rough conditions will mean that your tow bar also needs servicing. Check all mounting bolts regularly.